

Sterling Couch Range



Therapy Couch Range



Patient Trolley Range

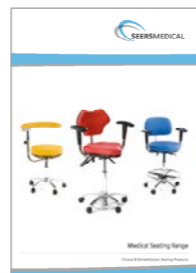

Seating Range



**SEERS MEDICAL Ltd**  
Kenton Road,  
Debenham, Suffolk  
IP14 6LA, United Kingdom  
© Copyright SEERS Medical Ltd 2021

Company Reg. N° 6572698  
VAT N° 931596702  
Printed in the United Kingdom

Note<sup>1</sup>: The illustrated fabric colours may vary slightly from actual fabric supplied. This occurs due to the four colour printing process. However every attempt has been made to make them as accurate as possible. Our Policy of continuous improvement means that we reserve the right to change and modify designs without prior notice. Note<sup>2</sup>: Measurements may vary +/- 2° or +/- 5mm due to manufacturing tolerances

ISO 13485 ISO 9001 ISO 14001  
- 2016 - - 2008 - - 2015 -



**Tel** +44 (0)1728 861 590  
**Fax** +44 (0)1728 861 868

info@seersmedical.com  
www.seersmedical.com

Issue N° 016 v2  
Part N° 06Z-8005-SF

## CLINNOVA Therapy Range

The New Market-Leading Range of Treatment Tables for Rehabilitation & Physiotherapy

## Introduction

In this new brochure we cover a wide range of patient examination furniture for various physiotherapy and rehabilitation techniques. The CLINNOVA design was started in 2018 to celebrate the 10th anniversary of SEERS Medical, in an effort to create a brand new range of market-leading treatment tables and examination couches. We listened to experts and professionals who use SEERS products every day to develop additional features and benefits not previously available on UK manufactured treatment couches.

With the management and control of our own assembly line at our premises in Debenham, Suffolk in the UK, our couches comply to the CE medical devices directive 93/42/EEC, ensuring we supply high quality products every time. We trust you will experience this yourself when you purchase a SEERS Medical product.

SEERS Medical are accredited with ISO 13485:2016, the Quality Management System for Medical Devices.

## Contents

- 4-15 CLINNOVA Therapy 2 Section
- 16-27 CLINNOVA Therapy 3 Section
- 28-31 CLINNOVA Therapy Drop End
- 32-35 CLINNOVA Therapy Hygiene
- 36-41 CLINNOVA Mobile Hygiene

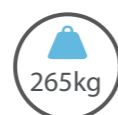

265kg

Safe working load  
265Kg (583lbs)



Mobile hoist clearance  
beneath frame



Anti-bacterial  
vinyl upholstery



Anti-mic  
powder coated frame



Crib 5

Crib 5 Fire  
retardant upholstery



Low Transfer Height

Low patient  
transfer height



Complies with EC  
Directive 93/42/EEC

## Technical Information

At SEERS Medical we are using state of the art design tools, such as 3D solid modelling and in house rapid prototyping, to assist us in getting new designs into development and manufacture. Whilst designing new products, all manufacturing capabilities available are taken into consideration, such as CNC wood cutting, laser profiling and robot welding, which deliver reliable build quality and repeatability of accurate components, time after time. A typical innovative use of these processes is evident in a high loaded component such as the ram bracket, a common item on many SEERS couches, where using laser profiling we have been able to make the parts interlock, adding immense strength, even before welding! This is typical of the attention to detail that we pride ourselves with, and sets us apart from other couch manufacturers, giving us confidence in the reliability and longevity of the products we manufacture.

### Mechanical Safety & Load Testing

All SEERS Medical products have been tested to the applicable EN 60601-1:2006+A12:2014 (E) the General requirements for basic safety and essential performance. Our couches have been thoroughly tested with a two and a half times safe working load (in excess of 600Kg loaded evenly, for in excess of one hour, to prove load support capability without failure. Our products are tested in accordance to Clauses 9.8.3.2-3 Static Forces of EN60601-1:2006 Not only do our products have high safe working loads (typically 240Kg), but our products also lift the rated safe working load from the minimum height to the maximum height smoothly.

### Electrical Safety

All SEERS Medical products comply to EN 60601-1:2006+A12:2014 (E) the General requirements for basic safety and essential performance. In addition, the actuation and control systems used on our products are marked with the UL mark, demonstrating compliance to UL60601-1 and CAN/CSA-C22.2 No. 601.1-M90, meeting the requirements for USA and Canada. The actuation control system is also marked with approval to C-ETL-US No. 3154358.

### CE Marking & Quality System

SEERS Medical operates a Quality Management System in accredited and approved to ISO 9001:2008. SEERS Medical products comply with the Essential Requirements in Annex I of EC Directive 93/42/EC, with all relevant design, production records, risk assessments, product testing and labelling information recorded in the documentation file labelled the "Technical File". All products carry a unique serial number for trace-ability of build date, model number and associated build records.

### Flammability

The upholstered couch sections satisfies flammability requirements to the standards of BS 7176:1995 (medium hazard) using ignition sources 0 (cigarette), 1 (gas) as defined in BS EN. 1921-1 and 2 and 5 (crib) BS 5852:1990.

### Warranty

The variable height couches detailed in this brochure have a lifetime frame warranty and five years warranty on all other components.



CAD design technology

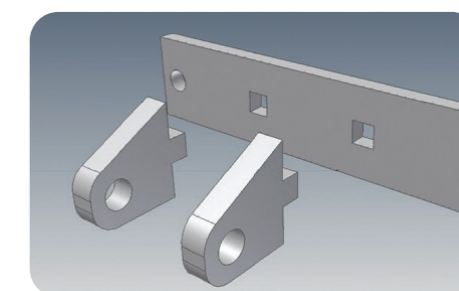

Interlocking structural components



Laser profiling

Width  
70cm



130cm

65cm

46cm to 95cm



## CLINNOVA Therapy 2 Section (Standard)



A very strong and rigid couch available with a wide range of accessories. Suitable for supporting very heavy patients for examination and minor treatment procedures.

### Models

See Page 6-7 for available models



Model NV2567-PRM  
with 9001 Perimeter Foot Switch  
Colour Poterie

### Standard Features

- Strong & sturdy design, supporting & lifting patients up to a maximum weight of 265Kg (583lbs)
- Gas assisted head section, adjustable from -20° to +80°
- Anti-trap gas assisted head section prevents risk of crushing and harm to patient, user or furniture
- Hydraulic pump action or electric height elevation
- Variable height range of 46 to 95cm for individual working heights
- Linked retractable wheels with adjustable foot for uneven floors
- Lock & Go transport mode for easy moving
- Purpose-made precision bearings ensure quiet, reliable operation and increase product life expectancy
- Frame design enables use of mobile hoist
- Electric models include a hand switch as standard
- Laser cut fixing points to easily retrofit approved accessories
- Anti-microbial paint additive on framework prevents growth of bacteria, fungi and viruses
- 70cm wide Easy Clean Upholstery conceals all visible staples
- Choice of 15 standard vinyl colours

### Optional Accessories

- 9001** Perimeter foot switch (NV2567 only)
- 6200** Single foot switch (NV2567 only)
- 9002** Side support rails (Pair)
- 9002P** Side support rail cushions (Pair)
- 9005** Paper Roll Holder
- 6007** Removable head/knee support
- 9008** Integral Face Cradle Cushion



Offset gas strut for unobstructed patient view  
through breathing hole



Model NV2557-CLS  
Colour Canard

## CLINNOVA Therapy 2 Section (Standard) - Models Available



### NV2557-CLS

Hydraulic Height Elevation  
Gas Assisted Head Section  
Classic Base



### NV2567-CLS

Electric Height Elevation  
Gas Assisted Backrest  
Hand or Foot Switch  
Classic Base



### NV2567-CLS-EPFS

Electric Height Elevation  
Gas Assisted Head Section  
Perimeter Foot Switch  
Classic Base



### NV2557-PRM

Hydraulic Height Elevation  
Gas Assisted Head Section  
Premium Base



### NV2567-PRM

Electric Height Elevation  
Gas Assisted Head Section  
Hand or Foot Switch  
Premium Base



### NV2567-PRM-EPFS

Electric Height Elevation  
Electric Head Section  
Perimeter Foot Switch  
Premium Base



## CLINNOVA Therapy 2 Section (Basic)



A very strong and rigid couch available with a wide range of accessories. Suitable for supporting very heavy patients for examination and minor treatment procedures.

### Models

See Page 10-11 for available models



Model NV2568-PRM  
with 9001 Perimeter Foot Switch  
Colour Light Grey

### Standard Features

- Strong & sturdy design, supporting & lifting patients up to a maximum weight of 265Kg (583lbs)
- Gas assisted head section, adjustable from -25° to +45°
- Anti-trap gas assisted head section prevents risk of crushing and harm to patient, user or furniture
- Hydraulic pump action or electric height elevation
- Variable height range of 46 to 95cm for individual working heights
- Linked retractable wheels with adjustable foot for uneven floors
- Lock & Go transport mode for easy moving
- Purpose-made precision bearings ensure quiet, reliable operation and increase product life expectancy
- Frame design enables use of mobile hoist
- Electric models include a hand switch as standard
- Laser cut fixing points to easily retrofit approved accessories
- Anti-microbial paint additive on framework prevents growth of bacteria, fungi and viruses
- 70cm wide Easy Clean Upholstery conceals all visible staples
- Choice of 15 standard vinyl colours

### Optional Accessories

- 9001** Perimeter foot switch (NV2568 only)
- 6200** Single foot switch (NV2568 only)
- 9002** Side support rails (Pair)
- 9002P** Side support rail cushions (Pair)
- 9005** Paper Roll Holder
- 6007** Removable head/knee support
- 9008** Integral Face Cradle Cushion



Offset gas strut for unobstructed patient view  
through breathing hole



Model NV2558-CLS  
Colour Burgundy

## CLINNOVA Therapy 2 Section (Basic) - Models Available



### NV2558-CLS

Hydraulic Height Elevation  
Gas Assisted Head Section  
Classic Base



### NV2568-CLS

Electric Height Elevation  
Gas Assisted Backrest  
Hand or Foot Switch  
Classic Base



### NV2568-CLS-EPFS

Electric Height Elevation  
Gas Assisted Head Section  
Perimeter Foot Switch  
Classic Base



### NV2558-PRM

Hydraulic Height Elevation  
Gas Assisted Head Section  
Premium Base



### NV2568-PRM

Electric Height Elevation  
Gas Assisted Head Section  
Hand or Foot Switch  
Premium Base



### NV2568-PRM-EPFS

Electric Height Elevation  
Electric Head Section  
Perimeter Foot Switch  
Premium Base



## CLINNOVA Therapy 2 Section (Plus)



A very strong and rigid couch available with a wide range of accessories. The plus head design features two adjustable arm supports for additional positioning techniques. Suitable for supporting very heavy patients.

### Models

See Page 14-15 for available models



Model NV2569-PRM  
with 9001 Perimeter Foot Switch  
Colour Red

### Standard Features

- Strong & sturdy design, supporting & lifting patients up to a maximum weight of 265Kg (583lbs)
- Gas assisted head section, adjustable from -25° to +45°
- Anti-trap gas assisted head section prevents risk of crushing and harm to patient, user or furniture
- Hydraulic pump action or electric height elevation
- Variable height range of 46 to 95cm for individual working heights
- Linked retractable wheels with adjustable foot for uneven floors
- Lock & Go transport mode for easy moving
- Purpose-made precision bearings ensure quiet, reliable operation and increase product life expectancy
- Frame design enables use of mobile hoist
- Electric models include a hand switch as standard
- Laser cut fixing points to easily retrofit approved accessories
- Anti-microbial paint additive on framework prevents growth of bacteria, fungi and viruses
- 70cm wide Easy Clean Upholstery conceals all visible staples
- Choice of 15 standard vinyl colours

### Optional Accessories

- 9001** Perimeter foot switch (NV2569 only)
- 6200** Single foot switch (NV2569 only)
- 9002** Side support rails (Pair)
- 9002P** Side support rail cushions (Pair)
- 9005** Paper Roll Holder
- 6007** Removable head/knee support
- 9008** Integral Face Cradle Cushion



Offset gas strut for unobstructed patient view  
through breathing hole



Model NV2559-CLS  
Colour Olive

## CLINNOVA Therapy 2 Section (Plus) - Models Available

### NV2559-CLS

Hydraulic Height Elevation  
Gas Assisted Head Section  
Classic Base



### NV2569-CLS

Electric Height Elevation  
Gas Assisted Backrest  
Hand or Foot Switch  
Classic Base



### NV2569-CLS-EPFS

Electric Height Elevation  
Gas Assisted Head Section  
Perimeter Foot Switch  
Classic Base



### NV2559-PRM

Hydraulic Height Elevation  
Gas Assisted Head Section  
Premium Base



### NV2569-PRM

Electric Height Elevation  
Gas Assisted Head Section  
Hand or Foot Switch  
Premium Base



### NV2569-PRM-EPFS

Electric Height Elevation  
Electric Head Section  
Perimeter Foot Switch  
Premium Base





Width  
70cm

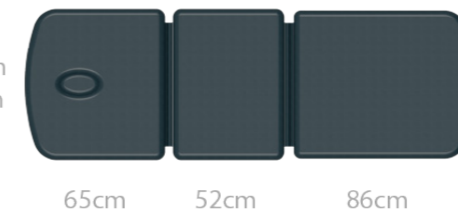

## CLINNOVA Therapy 3 Section (Standard)



A very strong and rigid couch available with a wide range of accessories. The additional section provides extra versatility and allows a seated position. Suitable for supporting very heavy patients.

### Models

See Page 18-19 for available models



Model NV3567-PRM  
with 9001 Perimeter Foot Switch  
Colour Dark Blue

### Standard Features

- Strong & sturdy design, supporting & lifting patients up to a maximum weight of 265Kg (583lbs)
- Gas assisted head section, adjustable from -20° to +80°
- Gas assisted foot section, adjustable from 0° to +70°
- Anti-trap gas assisted head section prevents risk of crushing
- Hydraulic pump action or electric height elevation
- Variable height range of 46 to 95cm for individual working heights
- Linked retractable wheels with adjustable foot for uneven floors
- Lock & Go transport mode for easy moving
- Purpose-made precision bearings ensure quiet, reliable operation and increase product life expectancy
- Frame design enables use of mobile hoist
- Electric models include a hand switch as standard
- Laser cut fixing points to easily retrofit approved accessories
- Anti-microbial paint additive on framework prevents growth of bacteria, fungi and viruses
- 70cm wide Easy Clean Upholstery conceals all visible staples

### Optional Accessories

- 9001** Perimeter foot switch (NV3567 only)
- 6200** Single foot switch (NV3567 only)
- 9003** Side support rails (Pair)
- 9003P** Side support rail cushions (Pair)
- 9005** Paper Roll Holder
- 6007** Removable head/knee support
- 9008** Integral Face Cradle Cushion



Offset gas strut for unobstructed patient view through breathing hole



Model NV3557-CLS  
Colour White

## CLINNOVA Therapy 3 Section (Standard) - Models Available



### NV3557-CLS

Hydraulic Height Elevation  
Gas Assisted Head Section  
Gas Assisted Foot Section  
Classic Base



### NV3567-CLS

Electric Height Elevation  
Gas Assisted Head Section  
Gas Assisted Foot Section  
Hand or Foot Switch  
Classic Base



### NV3567-CLS-EPFS

Electric Height Elevation  
Gas Assisted Head Section  
Gas Assisted Foot Section  
Perimeter Foot Switch  
Classic Base



### NV3550-PRM

Hydraulic Height Elevation  
Gas Assisted Head Section  
Gas Assisted Foot Section  
Premium Base



### NV3560-PRM

Electric Height Elevation  
Gas Assisted Head Section  
Gas Assisted Foot Section  
Hand or Foot Switch  
Premium Base



### NV3567-PRM-EPFS

Electric Height Elevation  
Gas Assisted Head Section  
Gas Assisted Foot Section  
Perimeter Foot Switch  
Premium Base

Width  
70cm

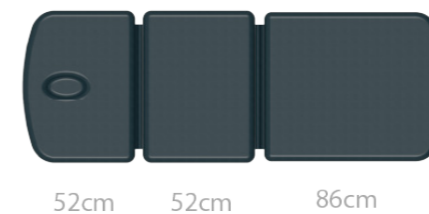

## CLINNOVA Therapy 3 Section (Basic)



A very strong and rigid couch available with a wide range of accessories. The additional section provides extra versatility and allows a seated position. Suitable for supporting very heavy patients.

### Models

See Page 18-19 for available models

### Standard Features

- Strong & sturdy design, supporting & lifting patients up to a maximum weight of 265Kg (583lbs)
- Gas assisted head section, adjustable from -25° to +45°
- Gas assisted foot section, adjustable from 0° to +70°
- Anti-trap gas assisted head section prevents risk of crushing
- Hydraulic pump action or electric height elevation
- Variable height range of 46 to 95cm for individual working heights
- Linked retractable wheels with adjustable foot for uneven floors
- Lock & Go transport mode for easy moving
- Purpose-made precision bearings ensure quiet, reliable operation and increase product life expectancy
- Frame design enables use of mobile hoist
- Electric models include a hand switch as standard
- Laser cut fixing points to easily retrofit approved accessories
- Anti-microbial paint additive on framework prevents growth of bacteria, fungi and viruses
- 70cm wide Easy Clean Upholstery conceals all visible staples
- Choice of 15 standard vinyl colours

### Optional Accessories

- 9001** Perimeter foot switch (NV3568 only)
- 6200** Single foot switch (NV3568 only)
- 9003** Side support rails (Pair)
- 9003P** Side support rail cushions (Pair)
- 9005** Paper Roll Holder
- 6007** Removable head/knee support
- 9008** Integral Face Cradle Cushion



Model NV3568-PRM  
with 9001 Perimeter Foot Switch  
Colour Sky Blue



Offset gas strut for unobstructed patient view  
through breathing hole



Model NV3558-CLS  
Colour Lotus Green

## CLINNOVA Therapy 3 Section (Basic) - Models Available



### NV3558-CLS

Hydraulic Height Elevation  
Gas Assisted Head Section  
Gas Assisted Foot Section  
Classic Base



### NV3568-CLS

Electric Height Elevation  
Gas Assisted Head Section  
Gas Assisted Foot Section  
Hand or Foot Switch  
Classic Base



### NV3568-CLS-EPFS

Electric Height Elevation  
Gas Assisted Head Section  
Gas Assisted Foot Section  
Perimeter Foot Switch  
Classic Base



### NV3558-PRM

Hydraulic Height Elevation  
Gas Assisted Head Section  
Gas Assisted Foot Section  
Premium Base



### NV3568-PRM

Electric Height Elevation  
Gas Assisted Head Section  
Gas Assisted Foot Section  
Hand or Foot Switch  
Premium Base



### NV3568-PRM-EPFS

Electric Height Elevation  
Gas Assisted Head Section  
Gas Assisted Foot Section  
Perimeter Foot Switch  
Premium Base

Width  
70cm



52cm 52cm 86cm



## CLINNOVA Therapy 3 Section (Plus)



A very strong and rigid couch available with a wide range of accessories. The additional section provides extra versatility and allows a seated position. Suitable for supporting very heavy patients.

### Models

See Page 26-27 for available models



Model NV3569-PRM  
with 9001 Perimeter Foot Switch  
Colour Canard

### Standard Features

- Strong & sturdy design, supporting & lifting patients up to a maximum weight of 265Kg (583lbs)
- Gas assisted head section, adjustable from -25° to +45°
- Gas assisted foot section, adjustable from 0° to +80°
- Anti-trap gas assisted head section prevents risk of crushing
- Hydraulic pump action or electric height elevation
- Variable height range of 46 to 95cm for individual working heights
- Linked retractable wheels with adjustable foot for uneven floors
- Lock & Go transport mode for easy moving
- Purpose-made precision bearings ensure quiet, reliable operation and increase product life expectancy
- Frame design enables use of mobile hoist
- Electric models include a hand switch as standard
- Laser cut fixing points to easily retrofit approved accessories
- Anti-microbial paint additive on framework prevents growth of bacteria, fungi and viruses
- 70cm wide Easy Clean Upholstery conceals all visible staples

### Optional Accessories

- 9001** Perimeter foot switch (NV3569 only)
- 6200** Single foot switch (NV3569 only)
- 9003** Side support rails (Pair)
- 9003P** Side support rail cushions (Pair)
- 9005** Paper Roll Holder
- 6007** Removable head/knee support
- 9008** Integral Face Cradle Cushion



Adjustable armrests included as standard  
on Plus models



Model NV3559-CLS  
Colour Burgundy

## CLINNOVA Therapy 3 Section (Plus) - Models Available



### NV3559-CLS

Hydraulic Height Elevation  
Gas Assisted Head Section  
Gas Assisted Foot Section  
Classic Base



### NV3569-CLS

Electric Height Elevation  
Gas Assisted Head Section  
Gas Assisted Foot Section  
Hand or Foot Switch  
Classic Base



### NV3569-CLS-EPFS

Electric Height Elevation  
Gas Assisted Head Section  
Gas Assisted Foot Section  
Perimeter Foot Switch  
Classic Base



### NV3559-PRM

Hydraulic Height Elevation  
Gas Assisted Head Section  
Gas Assisted Foot Section  
Premium Base



### NV3569-PRM

Electric Height Elevation  
Gas Assisted Head Section  
Gas Assisted Foot Section  
Hand or Foot Switch  
Premium Base



### NV3569-PRM-EPFS

Electric Height Elevation  
Gas Assisted Head Section  
Gas Assisted Foot Section  
Perimeter Foot Switch  
Premium Base

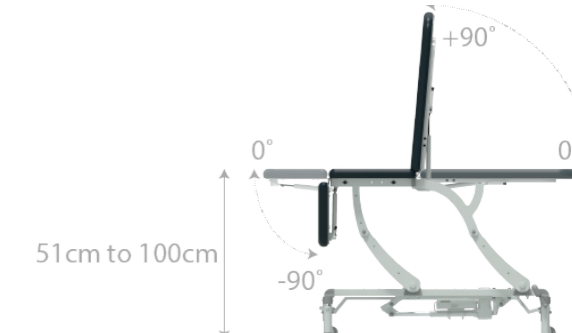
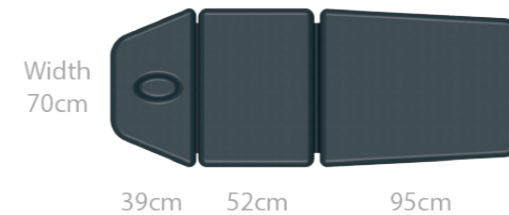

## CLINNOVA Therapy Drop End



An extremely strong and rigid 3 section couch, incorporating both an adjustable angle backrest and a single drop end head section, these models are suitable for a wide range of manual therapy and patient examination procedures.

### Models

See Page 30-31 for available models



Model NV3566-PRM  
with 9001 Perimeter Foot Switch  
Colour Red

### Standard Features

- Strong & sturdy design, supporting & lifting patients up to a maximum weight of 265Kg (583lbs)
- Gas assisted head section, adjustable from 0° to -90°
- Gas assisted foot section, adjustable from 0° to +90°
- Anti-trap gas assisted sections prevent risk of crushing
- Hydraulic pump action or electric height elevation
- Variable height range of 51 to 100cm for individual working heights
- Linked retractable wheels with adjustable foot for uneven floors
- Lock & Go transport mode for easy moving
- Purpose-made precision bearings ensure quiet, reliable operation and increase product life expectancy
- Frame design enables use of mobile hoist
- Electric models include a hand switch as standard
- Laser cut fixing points to easily retrofit approved accessories
- Anti-microbial paint additive on framework prevents growth of bacteria, fungi and viruses
- 70cm wide Easy Clean Upholstery conceals all visible staples
- Choice of 15 standard vinyl colours

### Optional Accessories

- 9001** Perimeter foot switch (NV3566 only)
- 6200** Single foot switch (NV3566 only)
- 9003** Side support rails (Pair)
- 9003P** Side support rail cushions (Pair)
- 9005** Paper Roll Holder
- 6007** Removable head/knee support
- 9008** Integral Face Cradle Cushion



NV9008 Integral Face Cradle Cushion  
ensures patient comfort while prone



Model NV3556-CLS  
Colour Dark Grey

## CLINNOVA Therapy Drop End - Models Available



### NV3556-CLS

Hydraulic Height Elevation  
Gas Assisted Head Section  
Gas Assisted Foot Section  
Classic Base



### NV3566-CLS

Electric Height Elevation  
Gas Assisted Head Section  
Gas Assisted Foot Section  
Hand or Foot Switch  
Classic Base



### NV3566-CLS-EPFS

Electric Height Elevation  
Gas Assisted Head Section  
Gas Assisted Foot Section  
Perimeter Foot Switch  
Classic Base



### NV3556-PRM

Hydraulic Height Elevation  
Gas Assisted Head Section  
Gas Assisted Foot Section  
Premium Base



### NV3566-PRM

Electric Height Elevation  
Gas Assisted Head Section  
Gas Assisted Foot Section  
Hand or Foot Switch  
Premium Base



### NV3566-PRM-EPFS

Electric Height Elevation  
Gas Assisted Head Section  
Gas Assisted Foot Section  
Perimeter Foot Switch  
Premium Base



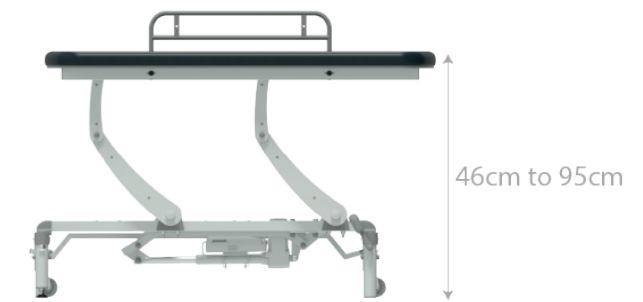
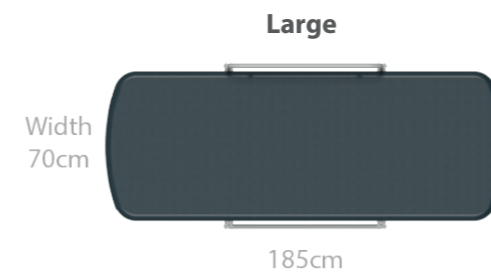
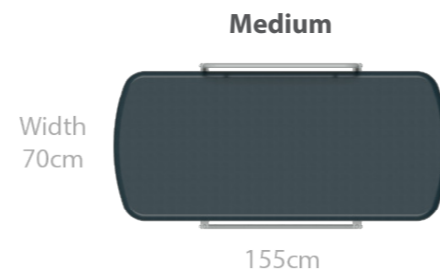
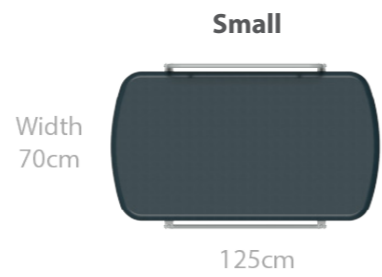

## CLINNOVA Therapy Hygiene



A selection of sturdy, variable height changing tables suitable for individuals with additional living needs. Popular within schools for children with special educational needs, but also suitable for adolescents and adults.

## Models

See Page 34-35 for available models

## Standard Features

- Strong & sturdy design, supporting & lifting patients up to a maximum weight of 265Kg (583lbs)
- Choice of Small, Medium or Large upholstery surfaces
- Hydraulic pump action or electric height elevation
- Variable height range of 46 to 95cm for individual working heights
- Linked retractable wheels with adjustable foot for uneven floors
- Lock & Go transport mode for easy moving
- Purpose-made precision bearings ensure quiet, reliable operation and increase product life expectancy
- Frame design enables use of mobile hoist
- Electric models include a hand switch as standard
- Anti-microbial paint additive on framework prevents growth of bacteria, fungi and viruses
- 70cm wide Easy Clean Upholstery conceals all visible staples
- Choice of 15 standard vinyl colours

## Optional Accessories

- 6200** Single foot switch (*NV1561 only*)
- 9002P** Side support rail cushions (Pair)



Model NV1561A-PRM  
Colour Dark Blue



Side Support Rails  
Fitted as Standard



Model NV1551C-CLS  
Colour Sky Blue

## CLINNOVA Therapy Hygiene - Models Available



**NV1551A-CLS**

Hydraulic Height Elevation  
Large  
Classic Base



**NV1561A-CLS**

Electric Height Elevation  
Large  
Classic Base



**NV1551B-CLS**

Hydraulic Height Elevation  
Medium  
Classic Base



**NV1561B-CLS**

Electric Height Elevation  
Medium  
Classic Base



**NV1551C-CLS**

Hydraulic Height Elevation  
Small  
Classic Base



**NV1561C-CLS**

Electric Height Elevation  
Small  
Classic Base



**NV1551A-PRM**

Hydraulic Height Elevation  
Large  
Premium Base



**NV1561A-PRM**

Electric Height Elevation  
Large  
Premium Base



**NV1551B-PRM**

Hydraulic Height Elevation  
Medium  
Premium Base



**NV1561B-PRM**

Electric Height Elevation  
Medium  
Premium Base



**NV1551C-PRM**

Hydraulic Height Elevation  
Small  
Premium Base



**NV1561C-PRM**

Electric Height Elevation  
Small  
Premium Base

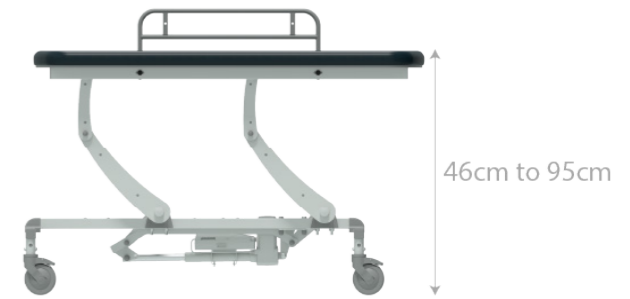
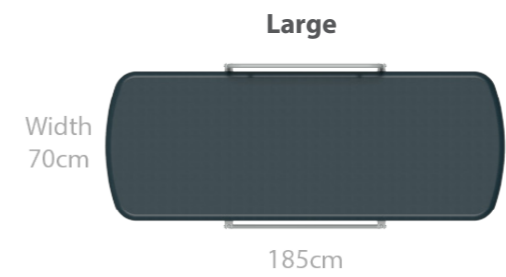
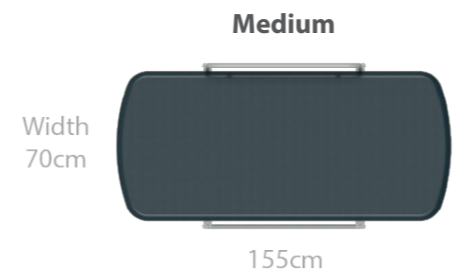
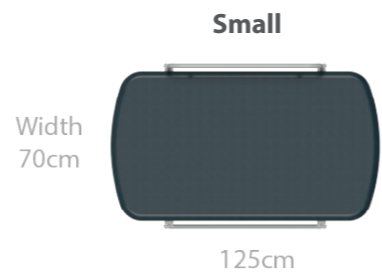

## CLINNOVA Mobile Hygiene



A selection of easily transportable, variable height changing tables suitable for individuals with additional living needs. Popular within schools for children with special educational needs, but also suitable for adolescents and adults.

### Models

See Page 38-41 for available models

### Standard Features

- Strong & sturdy design, supporting & lifting patients up to a maximum weight of 265Kg (583lbs)
- Choice of Small, Medium or Large upholstery surfaces
- Hydraulic pump action or electric height elevation
- Variable height range of 46 to 95cm for individual working heights
- Choice of 125mm independent or central locking castors
- Purpose-made precision bearings ensure quiet, reliable operation and increase product life expectancy
- Frame design enables use of mobile hoist
- Electric models include a hand switch as standard
- Anti-microbial paint additive on framework prevents growth of bacteria, fungi and viruses
- 70cm wide Easy Clean Upholstery conceals all visible staples
- Choice of 15 standard vinyl colours

### Optional Accessories

- 6200** Single foot switch (*NV1X61 only*)
- 9002P** Side support rail cushions (Pair)



Model NV1651A-PRM  
Colour Lotus Green



Side Support Rails  
Fitted as Standard



Model NV1451B-CLS  
Colour Dark Blue

## CLINNOVA Mobile Hygiene - Models Available



### NV1451A-CLS

Hydraulic Height Elevation  
Large  
Independently Braking Castors  
Classic Base



### NV1461A-CLS

Electric Height Elevation  
Large  
Independently Braking Castors  
Classic Base



### NV1451B-CLS

Hydraulic Height Elevation  
Medium  
Independently Braking Castors  
Classic Base



### NV1461B-CLS

Electric Height Elevation  
Medium  
Independently Braking Castors  
Classic Base



### NV1451C-CLS

Hydraulic Height Elevation  
Small  
Independently Braking Castors  
Classic Base



### NV1461C-CLS

Electric Height Elevation  
Small  
Independently Braking Castors  
Classic Base



### NV1451A-PRM

Hydraulic Height Elevation  
Large  
Independently Braking Castors  
Premium Base



### NV1461A-PRM

Electric Height Elevation  
Large  
Independently Braking Castors  
Premium Base



### NV1451B-PRM

Hydraulic Height Elevation  
Medium  
Independently Braking Castors  
Premium Base



### NV1461B-PRM

Electric Height Elevation  
Medium  
Independently Braking Castors  
Premium Base



### NV1451C-PRM

Hydraulic Height Elevation  
Small  
Independently Braking Castors  
Premium Base



### NV1461C-PRM

Electric Height Elevation  
Small  
Independently Braking Castors  
Premium Base

## CLINNOVA Mobile Hygiene - Models Available



### NV1651A-CLS

Hydraulic Height Elevation  
Large  
Central Locking Castors  
Classic Base



### NV1661A-CLS

Electric Height Elevation  
Large  
Central Locking Castors  
Classic Base



### NV1651B-CLS

Hydraulic Height Elevation  
Medium  
Central Locking Castors  
Classic Base



### NV1661B-CLS

Electric Height Elevation  
Medium  
Central Locking Castors  
Classic Base



### NV1651C-CLS

Hydraulic Height Elevation  
Small  
Central Locking Castors  
Classic Base



### NV1661C-CLS

Electric Height Elevation  
Small  
Central Locking Castors  
Classic Base



### NV1651A-PRM

Hydraulic Height Elevation  
Large  
Central Locking Castors  
Premium Base



### NV1661A-PRM

Electric Height Elevation  
Large  
Central Locking Castors  
Premium Base



### NV1651B-PRM

Hydraulic Height Elevation  
Medium  
Central Locking Castors  
Premium Base



### NV1661B-PRM

Electric Height Elevation  
Medium  
Central Locking Castors  
Premium Base



### NV1651C-PRM

Hydraulic Height Elevation  
Small  
Central Locking Castors  
Premium Base



### NV1661C-PRM

Electric Height Elevation  
Small  
Central Locking Castors  
Premium Base

## Optional Accessories



**6200**

Single foot switch option (alternative to standard single hand switch).



**6207**

Double foot switch option (alternative to standard double hand switch).

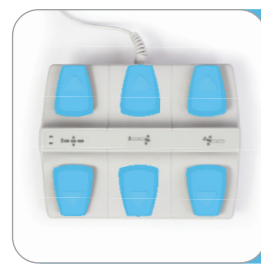

**6209**

Triple foot switch option (alternative to standard triple hand switch).



**6001**

The perimeter foot switch is a "hands free" foot operated system for height adjustment. Medicare 2 & 3 sections only.



**6057**

Battery back-up available for most electric operated models.



**6052 & 6053**

An easy to clean protective base frame cover that conceals the moving parts of the framework.



**6002 & 6003**

Fold-down side support rails for 2 & 3 section couches, providing patient support and security.



**6002P & 6003P**

Upholstered cushions can be added to the side support rails for additional comfort, support and protection.

If you have any queries on any of the optional accessories listed above please contact us for further details. Please note some of the accessories are supplied as standard with specific couches so please ensure you check before purchasing your chosen product as all other options come at an additional cost.



**6041**

Side support loops provide patient support and security and are easily removable.



**6054**

Telescopic IV pole has fixing points on both sides of the couch and is easily adjusted to the required height.



**6005**

The paper roll holder provides a protective barrier between the patient and the upholstered surface.



**6004**

Breathing hole & plug for improved patient comfort for prone treatments.



**6007**

The head support cushion is easily attached to the couch and can also be used as a support for lower limbs.



**6006**

The upper limb support has multi-angular adjustment and can be fitted to either side of the couch.



**5008**

The knee roll support set is an ideal accessory for supporting limbs during medical procedures.



**6020**

A light weight free-standing adjustable leg support for lower limb procedures. Supplied with carrying case.

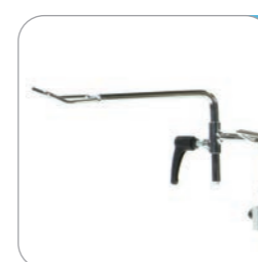

**6044**

Traditional lithotomy stirrups for gynaecology procedures.



**6045**

Leg supports for gynaecology procedures. Fully adjustable for patient comfort and security.

## Chairs & Stools



**MC6158**  
Surgeons / Sonographers chair, standard model. Height range of 45-59cm. Polished aluminium gas strut, five star base and castors.



**MC6178**  
Round general medical chair, standard model. Height range of 45-59cm. Polished aluminium gas strut, five star base and castors.



**6100**  
Standard operators chair with 2 lever operation for height and backrest angle. Height range of 48-60cm. Black five star base and castors.



**6101**  
High operators chair with 2 lever operation for height and backrest angle. Height range of 53-73cm. Adjustable foot support ring. Black five star base and glides.



**6103**  
Standard operators stool with all round release lever for height adjustment with range of 48-60cm. Black five star base and castors.



**6104**  
High operators stool with all round release lever for height adjustment with range of 53-73cm. Adjustable foot support ring. Black five star base and glides.



**6144**  
Economy saddle stool with single lever height adjustment with a range of 48-60cm. Black five star base and castors.



**MC6107**  
Deluxe saddle chair with 2 lever operation for height and seat tilt facility. Height range of 54-71cm. Polished aluminium five star base and castors.

Note<sup>1</sup>: See Medical Seating brochure for more options.

## Standard Colour Range

A very hard wearing vinyl that will retain its performance for many years. Abrasion Resistance to 150,000 cycles.



### Other colours are available on request

Please Note: The illustrated vinyl colours may vary slightly from actual vinyl supplied. This occurs due to the four colour printing process. However every attempt has been made to make them as accurate as possible.